







GRANDIO®

G R E E N H O U S E S

CONCRETE ANCHORING KIT FOR GRANDIO SUMMIT FLAT MOUNT BASE KITS

CONCRETE ANCHORING KIT PARTS LIST FOR ALL SIZES

GRAPHIC	PART NAME	12X8	12X12	12X16	12X20	12X24	12X28	12X32
	TAPCON® SCREW	44	52	60	68	76	84	92
	1/4" MAGNETIC NUT SETTER SOCKET BIT	1	1	1	1	1	1	1
	5/32" CARBIDE DRILL BIT	1	1	1	1	1	1	1
	SEALING TAPE	50'	50'	100'	100'	100'	100'	100'

ADDITIONAL ITEMS NEEDED:

- HAMMER DRILL
- BUBBLE LEVEL
- TAPE MEASURE
- MARKER OR SOFT PENCIL
- SAFETY GLASSES OR GOGGLES

© 2018 Grandio Greenhouses, Backyard Living Source Inc. All rights reserved
2018 Manual Edition Summit Concrete Anchoring Kit

GRANDIO CONCRETE ANCHORING KIT PREPARATION

Before you begin, take time to complete this check list. ✓

- **1.** Prepare your base surface a few weeks prior to installation when using concrete or a cement material for your base to allow for proper drying time. You may want to hire a contractor for site prep and or pouring a concrete slab. Always check first for any building codes and permits that might be necessary. Always call 811 before you dig.
- **2.** Your Concrete slab should be at least 6 inches wider than your base kit on all sides to allow for proper drainage. Check with your concrete contractor prior to drilling into fresh concrete to avoid cracking or breaking green concrete.
- **3.** Assemble your Grandio Base Kit according to the instructions in your GRANDIO SUMMIT GREENHOUSE MANUAL 1. The detailed dimensions are listed in the manual for each size base kit.
- **4.** Carefully apply the foam tape sticky side to the center of the bottom side of your base kit. Cut the tape to leave the holes for the anchors open for the bolt entry. This will create a seal for the base kit to the concrete helping to block drafts.
- **5.** Lay your base kit into place, measure an even border around your base with the concrete to square up placement, then measure corner to corner for square, use a bubble level to check for any allowances needed. Note you may need to purchase some washers to shim if needed for an of level surface. Once you have aligned and squared your base, mark the surface through all holes with a marker to know where to drill holes into the concrete we recommend marking an “x” to help hit the center mark. Move the base kit and washers out of your way to allow for room to drill your holes into the concrete surface. Keep the washers and base aligned with the hole they will go back onto for quicker installation. Or if you are good with the drill use the base kit as your guide to drill the holes.

GRANDIO SUMMIT CONCRETE ANCHORING KIT INSTALLATION

STOP
You must confirm that the Flat Mount Base Kit is assembled correctly. See the graphics below.

Walk around your base kit and confirm that your notches on the flat mount base have approximately 23" between each other. No notches should be right next to each other. If your base is not correct, refer to Summit Manual 1 and research your exact greenhouse size to see the correct orientation.

IF YOU INSTALL AN INCORRECTLY ASSEMBLED FLAT MOUNT BASE KIT YOU WILL NOT BE ABLE TO PROCEED IN LATER SECTIONS!!

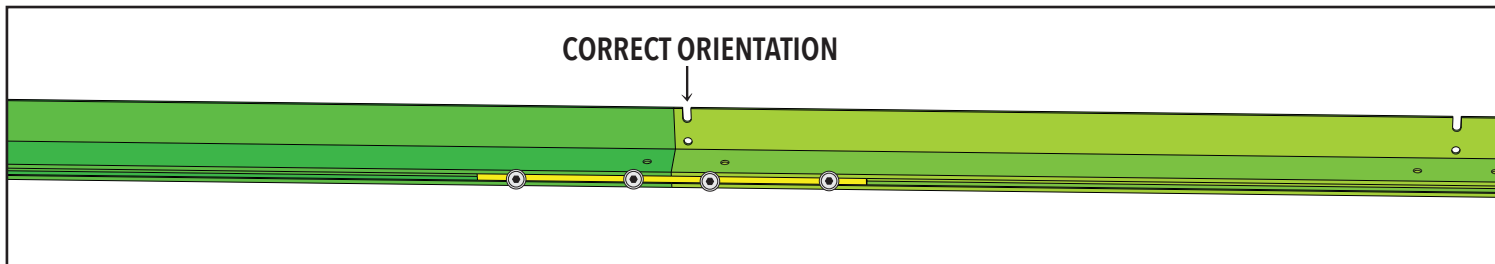
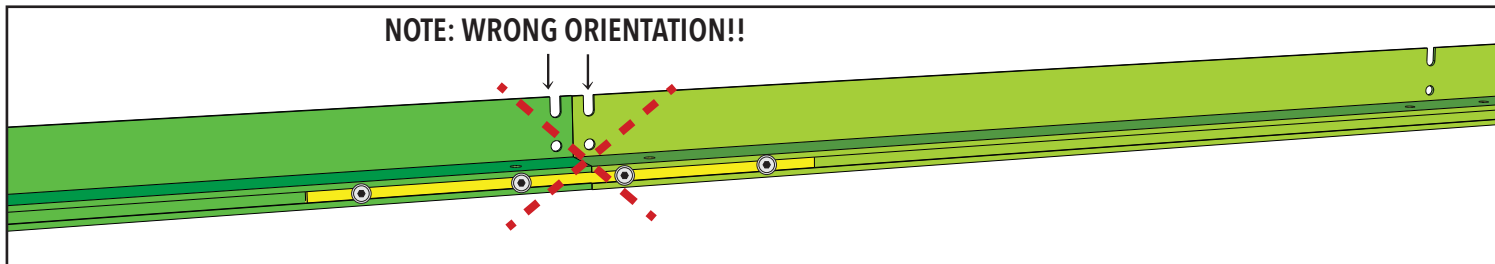
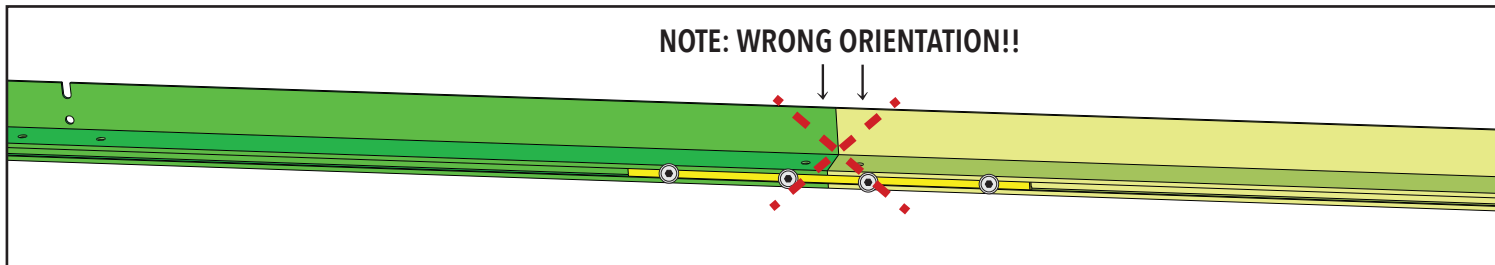

GRANDIO SUMMIT CONCRETE ANCHORING KIT INSTALLATION

NOTE: You will remove the front and back sections of the base kit to assemble the front and back walls of the greenhouse in GREENHOUSE ASSEMBLY MANUAL 2.

1. Align your Flat Mount Base Kit into place and square up to your surface, see the layout below, reference Manual 1 for your exact base size and dimensions as needed.

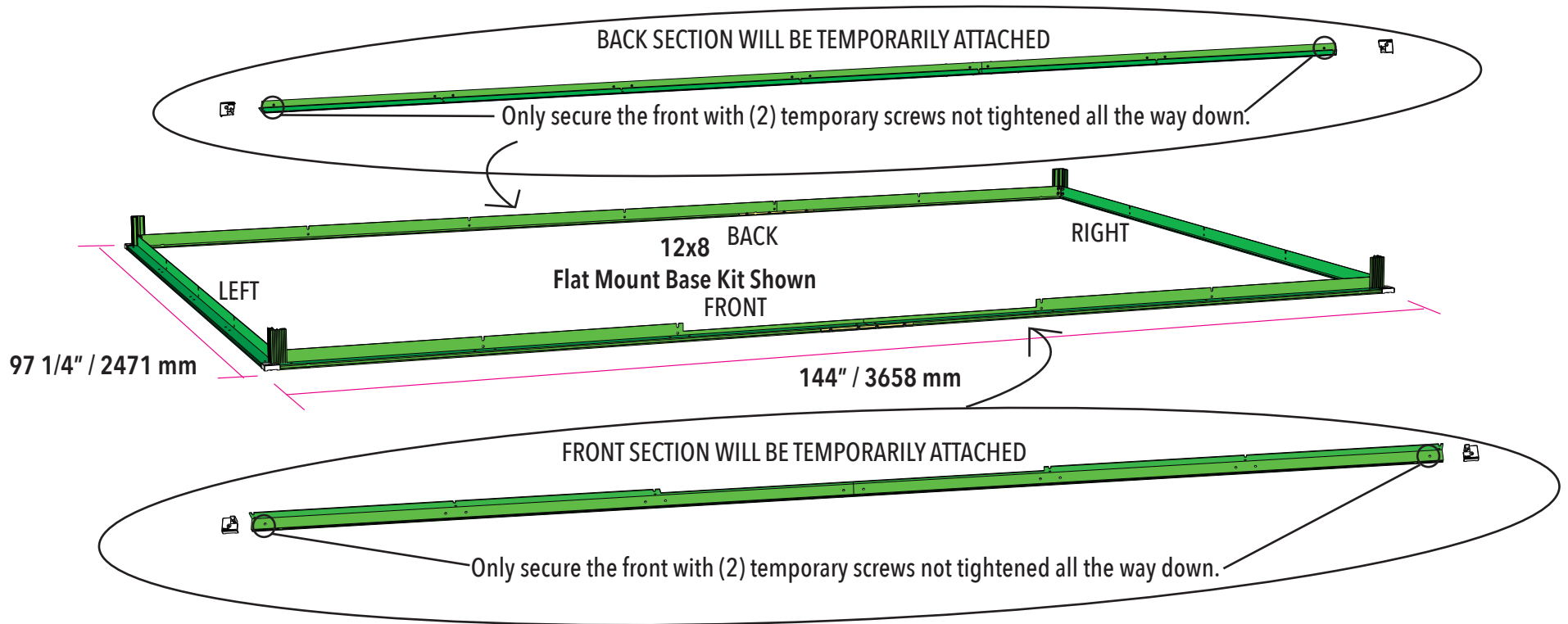

GRANDIO SUMMIT CONCRETE ANCHORING KIT INSTALLATION

**12X8 SUMMIT FLAT MOUNT BASE KIT SHOWN
SEE BASE INSTALLATION MANUAL 1
FOR YOUR EXACT CONFIGURATION LAYOUT**

2. You will drill all of the holes now using the provided 5/32" carbide drill bit, either use the base as your guide or mark each hole and then drill them out. **YOU WILL NEED A HAMMER DRILL, YOU CAN OFTEN RENT THESE LOCALLY.** The arrows around the outside edge point to each of the holes. You must remove the debris from the hole with a vacuum or canned air after drilling. See diagrams 1 and 2.
Tip: You may want to insert a few screws at the corners to keep the base squared while drilling if using the base kit in place as your drilling guide.

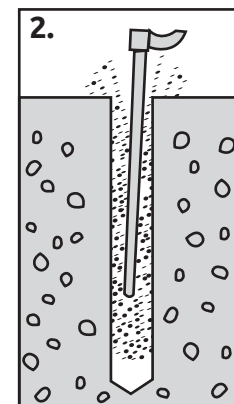
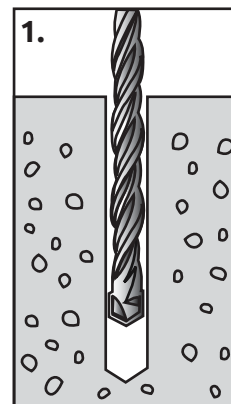
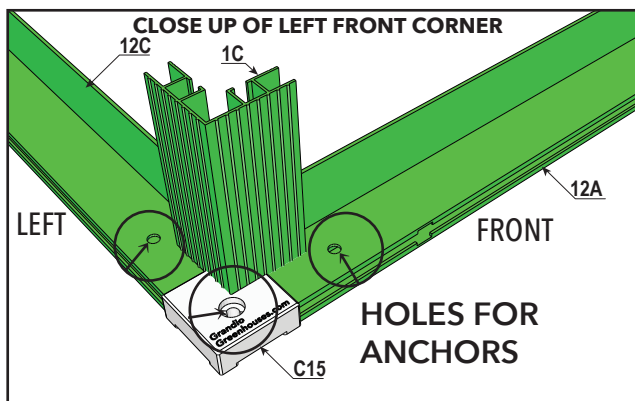

GRANDIO SUMMIT CONCRETE ANCHORING KIT INSTALLATION

3. Attach the sides using the he provided TAPCON® Screws with the Bit to secure the sides of the flat mount base kit onto your concrete surface. SEE DIAGRAMS **A** and **B** .

4. You will leave the secured sides in place. Remove the **TEMPORARY SCREWS** and set aside the **FRONT, BACK, C14** and **C15 CAPS**. Keep the provided anchoring screws in a safe place for the installation of the Front and Back Walls for later use in **SUMMIT MANUAL 2**.

