









GRANDIO

G R E E N H O U S E S

Trellising Kit Instructions

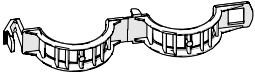

© 2013 Grandio Greenhouses, Backyard Living Source Inc. All rights reserved
May 10, 2017 Version

	<p>Roller Plast Assembly</p>	<p>Great for growing tomatoes, cucumbers or other vining fruits, vegetables and plants.</p> <ul style="list-style-type: none"> • Designed to avoid slipping or jumping from the spool lock, this unique assembly enables smooth lowering with full control. • Includes assembly body and a 15 meter spool of Roller Plast White Twine. <p>6</p>
	<p>Stem Holder</p>	<p>Stem Holders support your tomato, grape and other plant vines preventing plant damage. Ideal for difficult-to-manage stems and plants.</p> <ul style="list-style-type: none"> • Prevents drooping, bending and flopping, allowing plants to grow strong. • UV Protected <p>12</p>
	<p>Standard Clip 23mm</p>	<p>Connects plants to trellis twine quickly and easily.</p> <ul style="list-style-type: none"> • Aired clip promotes better ventilation and helps prevent fungus. • Quick release feature allows clips to be moved easily and to be saved and reused for multiple crops throughout a growing season. <p>24</p>
	<p>Two-Piece Radial Hooks</p>	<p>Two-Piece Radial Hooks support your tomato, grape and other plant vines preventing plant damage.</p> <ul style="list-style-type: none"> • Easy to use hook fits over wire with up to a 3.75 mm diameter. • This hook helps prevent plant breakage. <p>12</p>
	<p>Super J Double Cluster Support Hooks</p>	<p>Super J Double Cluster Support Hooks holds and support your tomato, grape and other plant vines healthy and prevent plant damage.</p> <ul style="list-style-type: none"> • Unique design offers support and prevents damage to the cluster stem. • Overall length is 3.5”. <p>12</p>
	<p>Plant Hanger Clip</p>	<p>Plant hanger clip fits inside the extrusion of Grandio and many other extrusion support style greenhouses.</p> <p>6</p>

1.1 Unwind about 12" of string from your Roller Plast Assembly, cut about 8" of the twine to tie a knot. Form a loop from the Plant Hanger Clip and the Roller Plast Assembly and tie the knot, see **A**. Wrap the string around the Roller Plast Assembly at the bottom to lock the twine in place, see **B**.

1.2 Insert the Plant Hanger Clip into the extrusion of your greenhouse roof frame as shown in **C**. Gently slide up the extrusion and then turn clockwise or to the right to lock into place, it will hold firm when tightened.

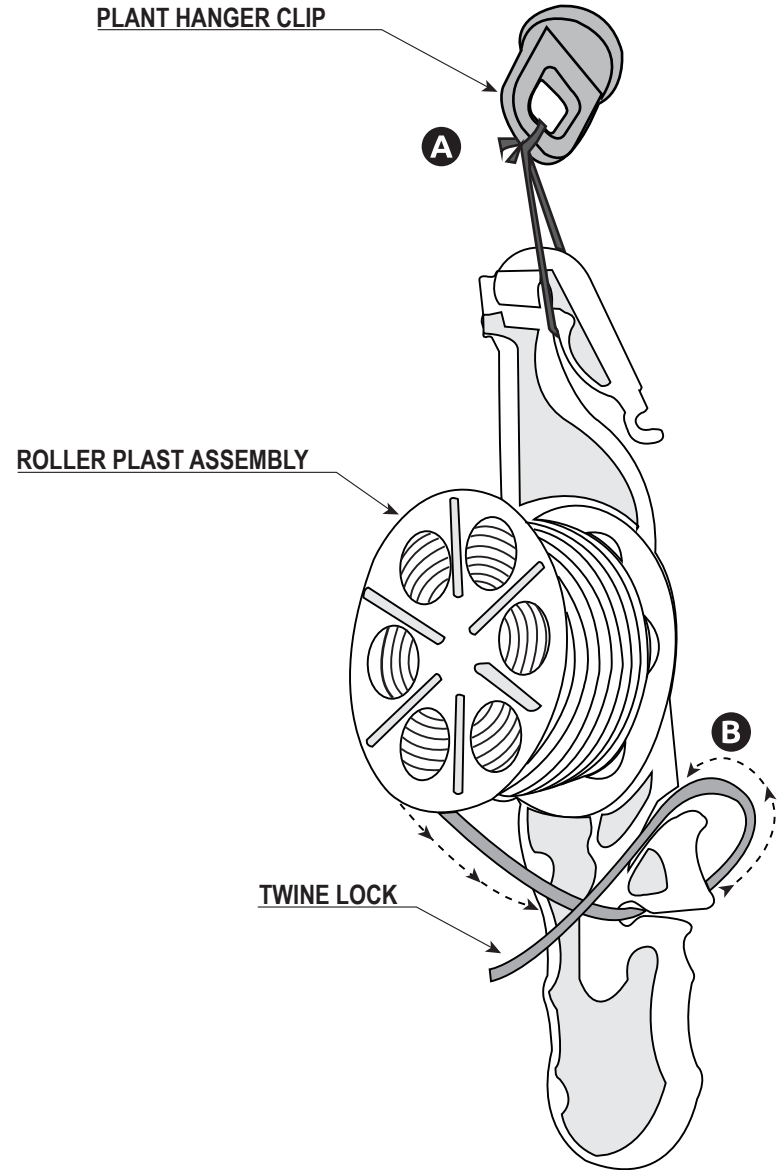
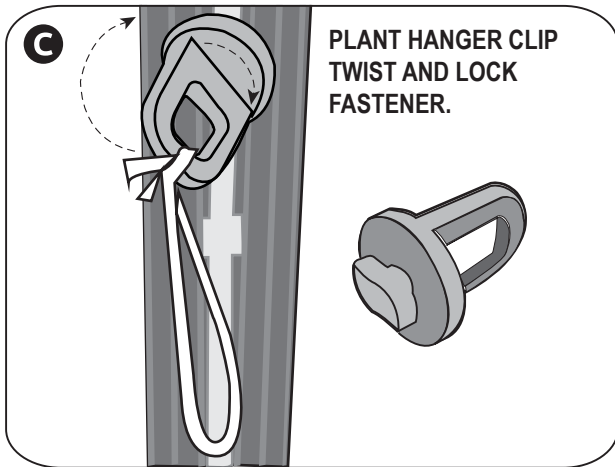

1.3 Locate the vine of the plant you want to trellis, unwind the string from the roller to the base of the plant. Wrap the string around the Roller Plast Assembly to lock the string in place.

1.4 Locate the Standard Clip, or the Two Piece Radial Hook that fits your plants needs best. Attach the clip or hook of your choice, then wind the vine of the plant counter clockwise around the twine so you will always know which way it winds as your plant grows. Attach more clips as needed, utilize the Super J Double Cluster Support Hooks and the Stem Holders as needed for your plant.

