





GRANDIO SUMMIT SHADE NET INSTALLATION

ALUMINET SHADE NET PARTS LIST FOR GRANDIO SUMMIT GREENHOUSES

Image	Part Name	12' x 8' Greenhouse	12' x 12' Greenhouse	12' x 16' Greenhouse	12' x 20' Greenhouse	12' x 24' Greenhouse	12' x 28' Greenhouse	12' x 32' Greenhouse
	Shade Net 50% ALUMINET SHADE NET	21' x 9'	21' x 13'	21' x 17'	(1) 21' x 9' and (1) 21' x 13'	(2) 21' x 13'	(1) 21' x 13' and (1) 21' x 17'	(2) 21' x 17'
	AFS-610 ALLEN FLANGED HEAD M6-100X10MM	10	14	16				
	M6 Square Nut	10	14	16				
	D-Ring	10	14	16				
	Rope	50'	100'	100'				

GRANDIO SUMMIT SHADE NET INSTALLATION

NOTE: Install your shade net on a calm day. It will require 2 people for installation.

1. Close all roof vents completely before beginning the installation of your shade net.
2. Install all of the anchoring hardware as shown in **A**, **B**, **C** and **D**. Loosely pre-thread the **AFS-610** screw and **SQUARE NUT** into the **D-Ring**. Using the notched access points, insert square nut into the track that runs along the outside bottom edge of your Grandio Summit Flat Mount Base Kit. Slide and position set in the tracker where desired and tighten screw with **D-Ring** facing up. The set should look like diagram when installed. **D**

Space out the hardware as desired for your greenhouse. Note the number of grommets to each side of the shade net according to the size you are installing so you space the hardware appropriately.

IMAGE SHOWS ASSEMBLED
HARWARE COMBO



A



B



C

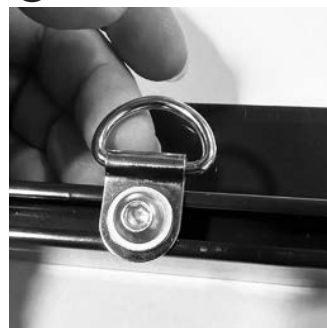

D



GRANDIO SUMMIT SHADE NET INSTALLATION

3. Place the shade net in front of your Greenhouse. The front of the shade net measures **21'**, fold the shade net in an accordion fashion for the easiest installation see **A** . If you are installing multiple shade nets on a longer greenhouse model, you may want to attach the shade nets in the middle with zip ties to hold the 21' edges together, or just thread the paracord thru all of the bottom edge grommets on the shade nets.
4. With the help of another person, lift the folded shade net and place it over the front of your greenhouse, then gently roll out across the entire greenhouse.
5. Open all Roof Vents, then use rope to tie the shade net down weaving from the grommets to the-Rings as shown in **B** . In the first hole, tie a regular square knot. In the last hole, tie the taut line knot, see **C** .

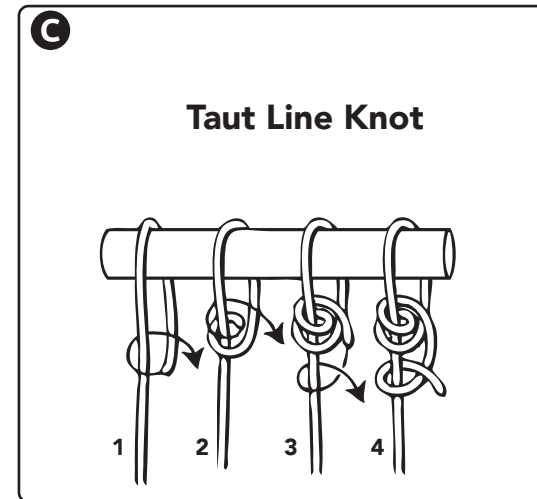
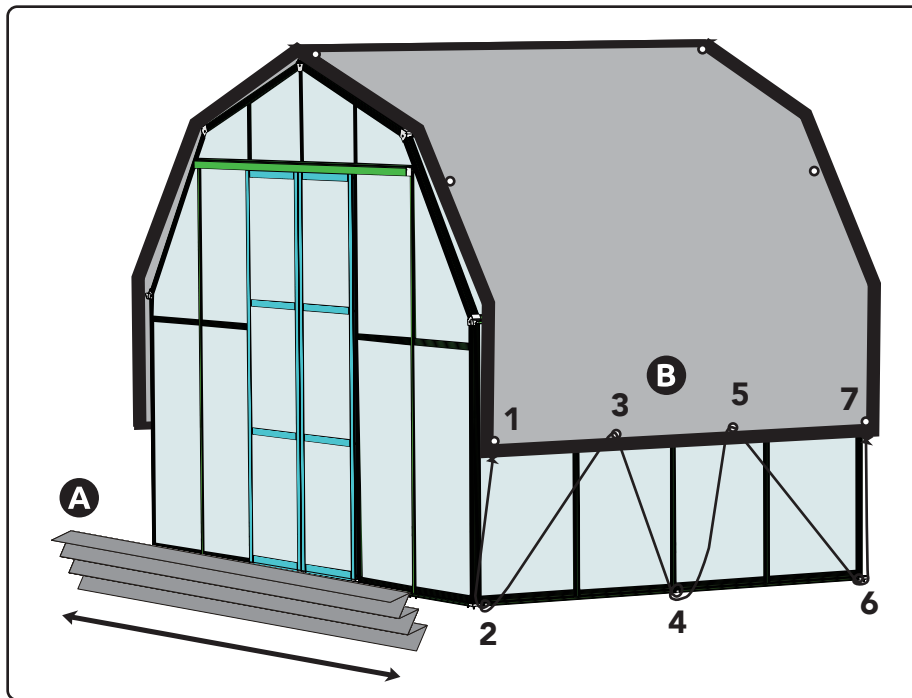

NOTE: Remove your shade net during seasons when not needed and store in a dry place.

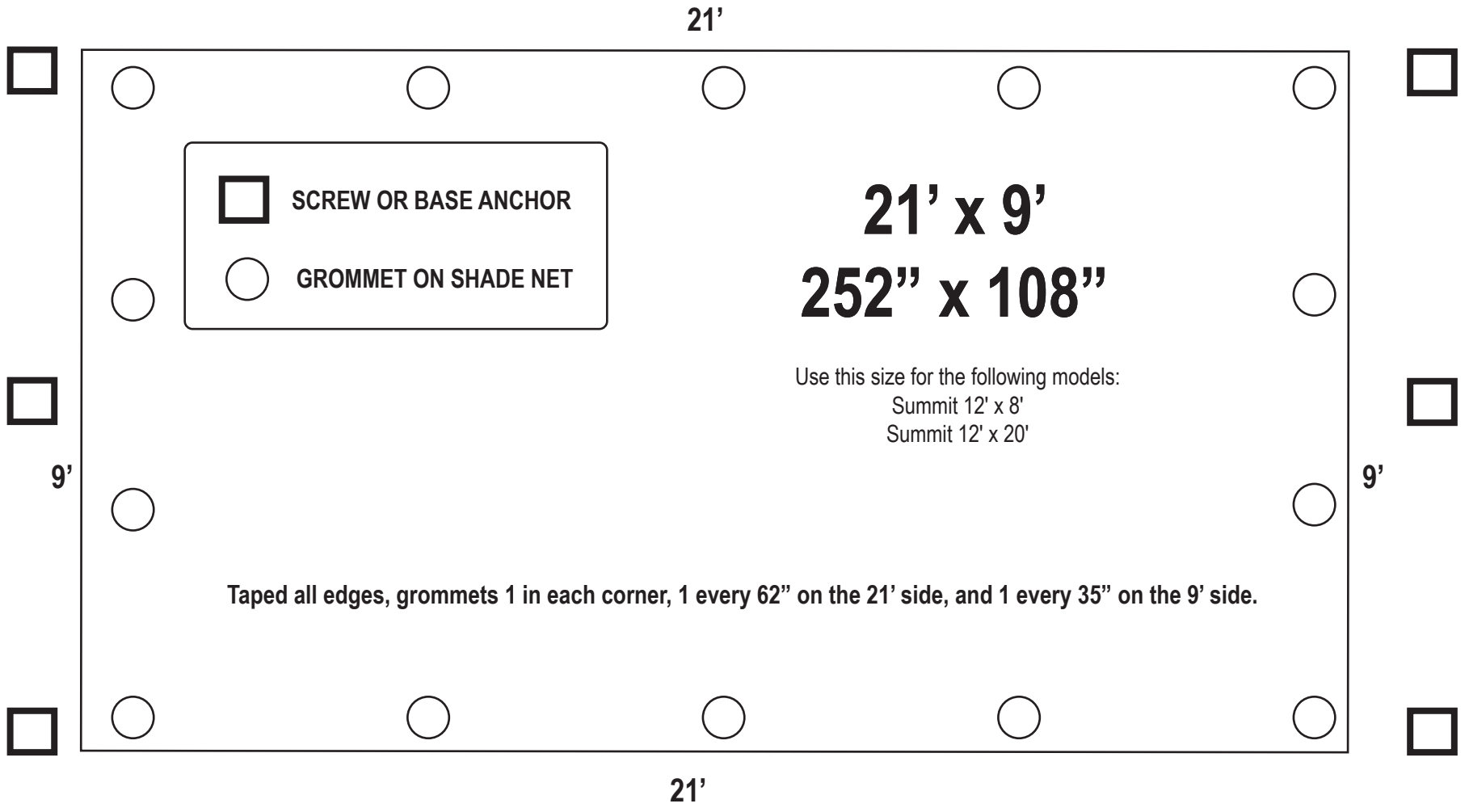



21'



 SCREW OR BASE ANCHOR
 GROMMET ON SHADE NET

21' x 9'
252'' x 108''

Use this size for the following models:
Summit 12' x 8'
Summit 12' x 20'



9'



9'

Taped all edges, grommets 1 in each corner, 1 every 62'' on the 21' side, and 1 every 35'' on the 9' side.



21'

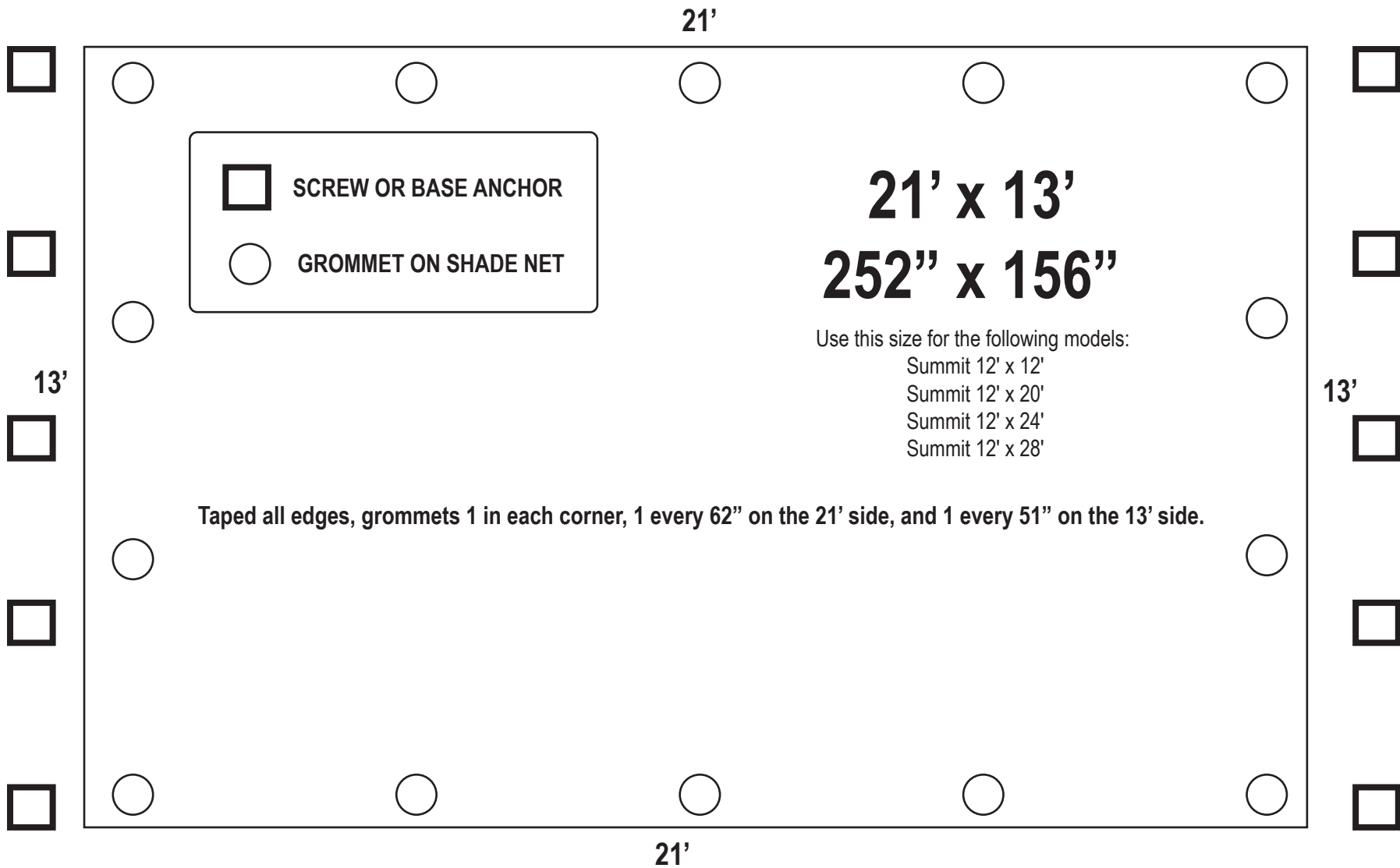

21'

□ SCREW OR BASE ANCHOR

○ GROMMET ON SHADE NET

21' x 13'
252" x 156"

Use this size for the following models:

Summit 12' x 12'

Summit 12' x 20'

Summit 12' x 24'

Summit 12' x 28'

13'



13'

Taped all edges, grommets 1 in each corner, 1 every 62" on the 21' side, and 1 every 51" on the 13' side.

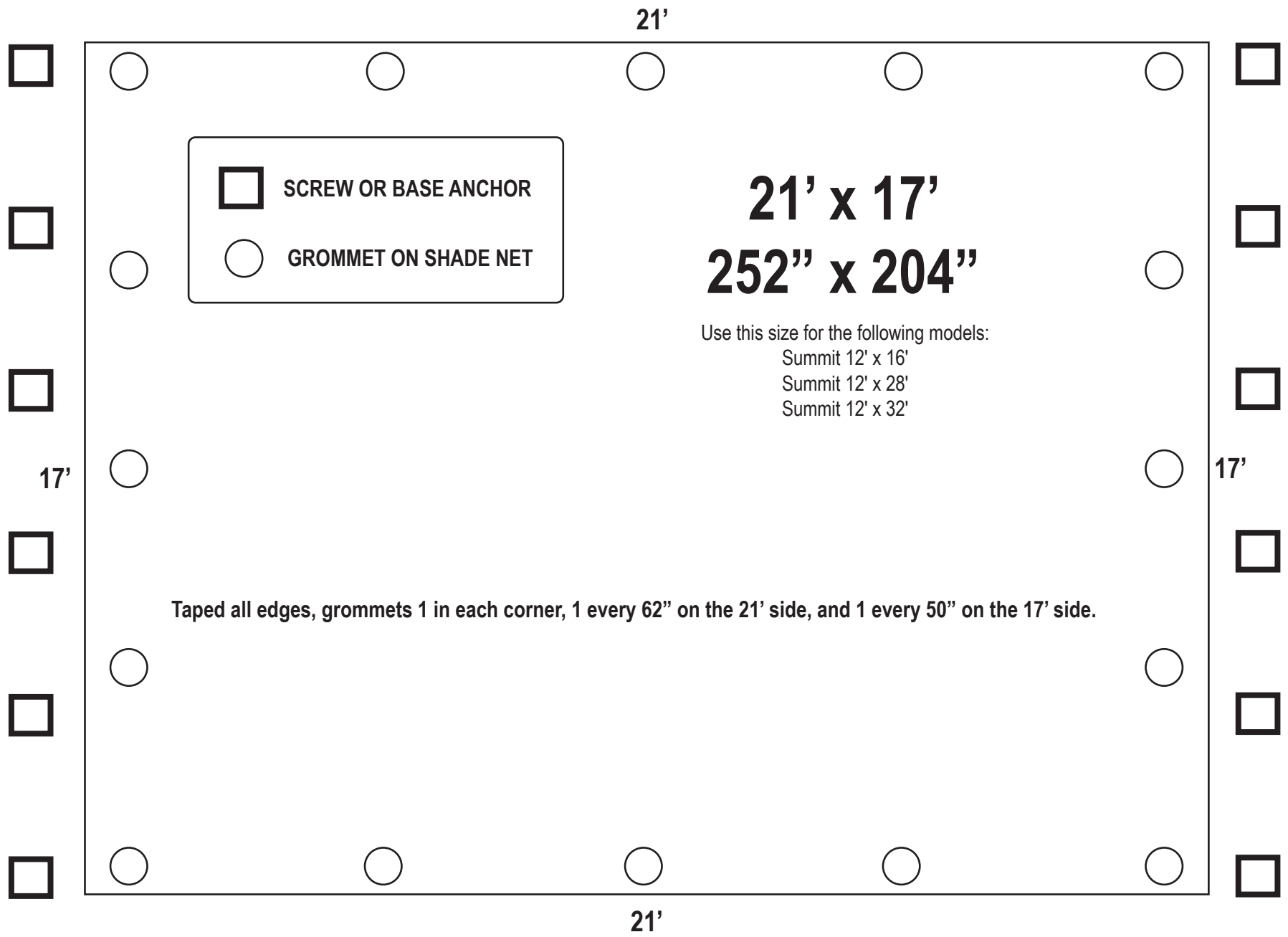
21'



21'

-  SCREW OR BASE ANCHOR
-  GROMMET ON SHADE NET

21' x 17'
252" x 204"

Use this size for the following models:
Summit 12' x 16'
Summit 12' x 28'
Summit 12' x 32'

17'

17'

Taped all edges, grommets 1 in each corner, 1 every 62" on the 21' side, and 1 every 50" on the 17' side.

21'